

# Dynapac CC1200

## Double drum vibratory rollers

Atlas Copco



### Technical data

 Masses	
Max. operating mass	2,710 kg
Operating mass (incl. ROPS)	2,600 kg
Module mass (front/rear)	1,260/1,340 kg

  

 Traction	
Speed range (Dual/TC/AS)	0-10 km/h
Vertical oscillation	±10°
Theor. gradeability	30 %

 Compaction	
Centrifugal force	33 kN
Nominal amplitude	0.5 mm
Static linear load (front/rear)	10.5/11.3 kg/cm
Vibration frequency	63 Hz
Water tank	160 l

 Engine	
Manufacturer/Model	Kubota D1703-M (T4i)
Type	Water cooled
Rated power, SAE J1995	26 kW (35 hp ) @ 2,800 rpm
Fuel tank capacity	50 l

 Hydraulic system	
Driving	Axial piston pump with variable displacement. Radial piston motors (2) with constant displacement.
Vibration	Gear pump/motors with constant displacement.
Steering	Gear pump with constant displacement.
Service brake	Hydrostatic in forward and reverse lever.
Parking/ Emergency brake	Failsafe multidisc brake in both drums.

Find us locally at [www.atlascopco.com](http://www.atlascopco.com)

We reserve the right to change specifications without notice. Photos and illustrations do not always show standard versions of machines. The above information is a general description only, all informations are supplied without liability.

rce\_cc1200\_en-20140905.100113.pdf 2014-09-05 10:01

# Dynapac CC1200

## Double drum vibratory rollers

Atlas Copco

### Technical data

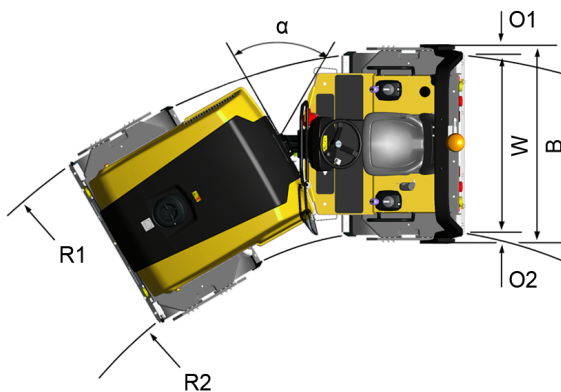
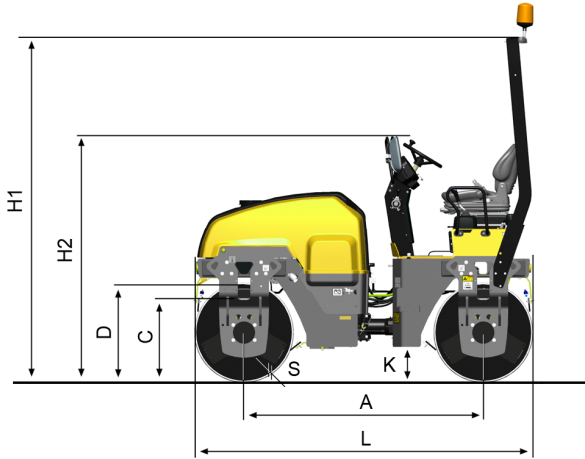

Dimensions	
A. Wheelbase	1,715 mm
B. Width	1,310 mm
C. Curb clearance	550 mm
D. Drum diameter	682 mm
H1. Height, with ROPS/cab	2,640 mm
H2. Height, w/o ROPS/cab	1,755 mm
K. Ground clearance	175 mm
L. Length	2,395 mm
O1. Overhang, right	40 mm
O2. Overhang, left	40 mm
R1. Turning radius, outside	3,800 mm
R2. Turning radius, inside	2,600 mm
S. Drum shell thickness	13 mm
W. Drum width	1,200 mm
$\alpha$ . Steering angle	$\pm 30^\circ$



#### Standard equipment

Backup alarm, Working lights



#### Optional equipment

3" seatbelt, Biodegradable hydraulic fluid, Cert. Fire protection (SBF 127), Decal risk location (GOST), Fire extinguisher, Foot rest, Hearing protectors, Licence plate light, Rear view mirror (traffic view), Service kit 50/500/1000H, Side direction lights (driving lights required), Slow moving vehicle sign, Special color (one or two), Tool set, Towing eyelet, Water tank cover (lockable)

Find us locally at [www.atlascopco.com](http://www.atlascopco.com)

We reserve the right to change specifications without notice. Photos and illustrations do not always show standard versions of machines. The above information is a general description only, all informations are supplied without liability.

rce\_cc1200\_en-20140905.100113.pdf 2014-09-05 10:01